

SL5 SERIES

The **SL5** sensors, thanks to the laser emission concentrated in a thin light beam, represent the ideal solution for the detection of very small objects or to reach very long operating distances. Precise detections with decimillimetre resolutions can be obtained with the proximity model at an operating distance ranging from 0 to 35 cm. High operating distances can be reached with the 12 m polarised retroreflex model, or with the 60 m through beam model; high-resolution detections at shorter distances can be effected also.

The visible red emission is generated by a Class 1 laser according to the EN 60825-1, guaranteeing the maximum safety in all applications.

The sensitivity adjustment trimmer and the LEDs indicating the output status and switching stability are positioned on the sturdy ABS tubular M18 housing with IP67 protection.



HIGHLIGHTS

- Visible red class 1 laser emission
- Proximity models for high-resolution detections
- Retroreflex and through beam versions for long operating distances
- Trimmer sensitivity adjustment and stability LED

APPLICATIONS

Ceramics

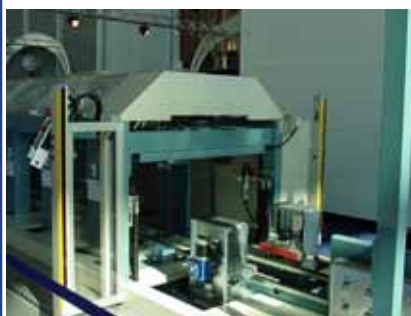

Transportation lines





Beverage & Bottling



Packaging lines



TECHNICAL DATA

Power supply:	10 ... 30 Vdc, reverse polarity protection
Consumption:	35 mA max.
Light emission:	red laser 650 nm
	safety class 1 according to EN 60825-1
Diffuse proximity operating distance:	0 ... 35 cm
Diffuse proximity resolution:	0.2 mm at a distance of 5 cm
	1 mm at a distance of 10 cm
	3 mm at a distance of 20 cm
	5 mm at distances over 30 cm
Polarised retroreflex operating distance:	0.03 ... 12 m (on R2)
	0.3 ... 7 m (on R7)
Polarised retroreflex resolution:	1 mm at a distance of 1 m (on R7/r8)
	2 mm at a distance of 3 m (on R7/r8)
	4 mm at a distance of 5 m (on R7)
	5 mm at distances over 7 m (on R2)
Through beam operating distance:	0 ... 60 m
Through beam resolution:	2.5 mm at a distance of 5 m
	5 mm at a distance of 10 m
	10 mm at distances over 20 m
Setting:	sensitivity trimmer
Indicators:	yellow OUTPUT LED
	green POWER LED (G. vers.)
	green STABILITY LED
Output type:	PNP, open collector
Saturation voltage:	2 V max.
Output current:	100 mA max., short-circuit protection
Response time:	333 ms max.
Switching frequency:	1.5 kHz max
Operating mode:	light or dark
Auxiliary functions:	'test +' input (G vers.)
Connection:	4-pole M12 connector
Electrical protection:	class 2
Mechanical protection:	IP67
Housing material:	ABS
Lens material:	PMMA plastic
Weight:	30 g max.
Operating temperature:	-10 ... +50°C
Storage temperature:	-25 ... +70°C
Reference standard:	EN 60947-5-2, EN 60825-1
Certifications:	 

DETECTION DIAGRAMS

SL5-5-C

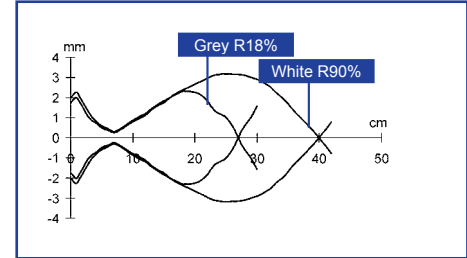

SL5-5-C resolution

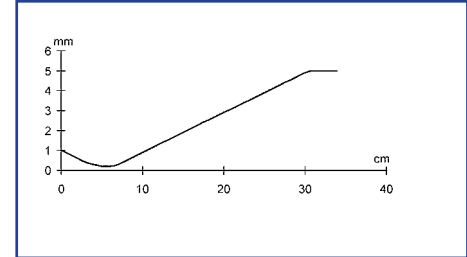

SL5-5-B

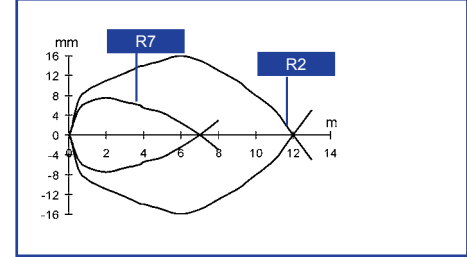

SL5-5-B resolution on R7

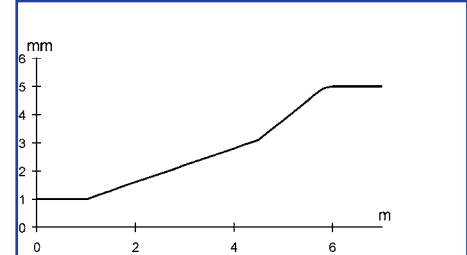

SL5-5-F/G

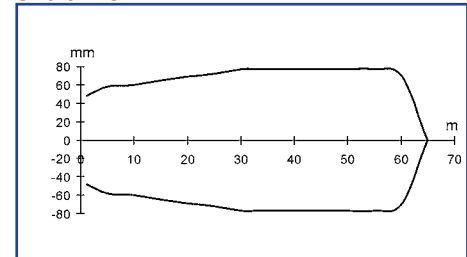

SL5-5-F/G resolution

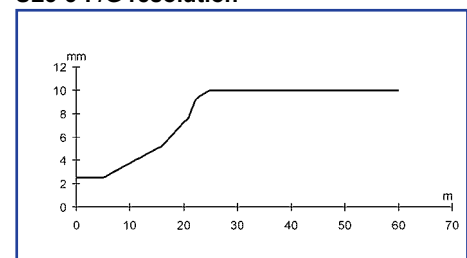

The detection diagrams indicate the typical operating distance with excess gain 1. The operating distances indicate the detection distance with excess gain 2.

CONNECTIONS

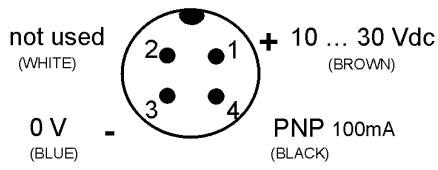

SL5-5-B/C/F

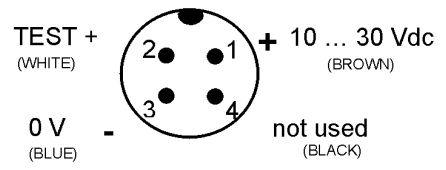

SL5-5-G

DIMENSIONS

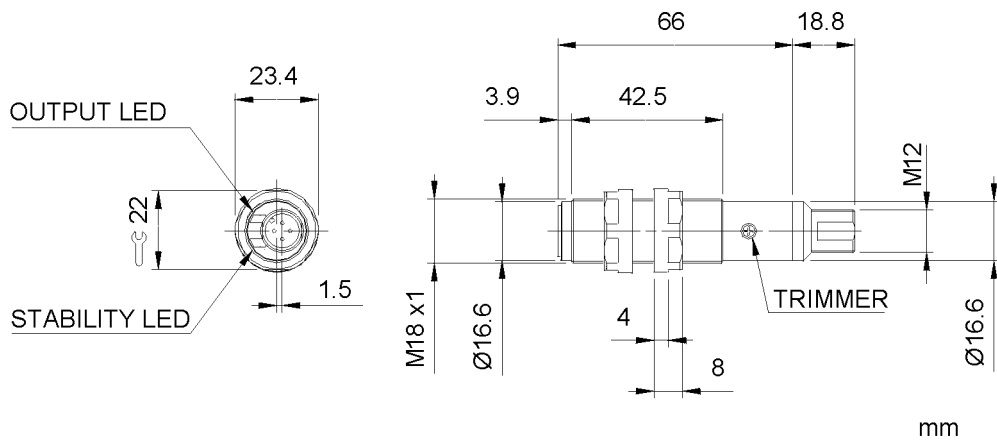

MICRO-18
support with micrometric regulation

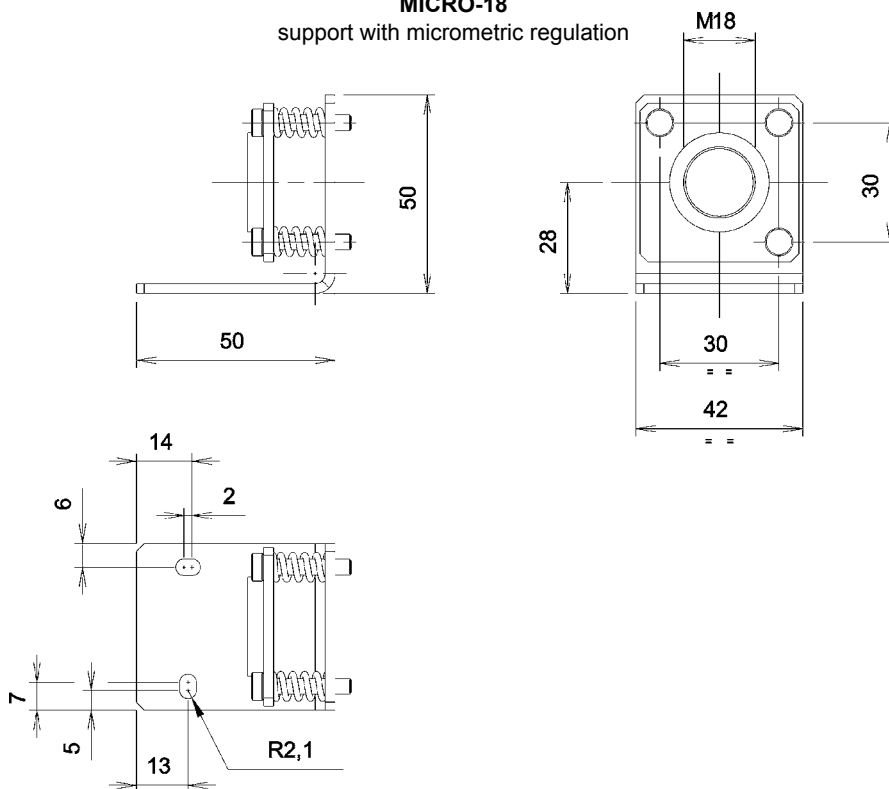

mm

MODEL SELECTION AND ORDER INFORMATION

MODEL	FUNCTION	CONNECTION	OUTPUT	CODE N°
SL5-5-B-82	polarised retroreflex	M12 connector	PNP-dark	952501010
SL5-5-B-92	polarised retroreflex	M12 connector	PNP-light	952501080
SL5-5-C-82	diffuse proximity	M12 connector	PNP-dark	952501090
SL5-5-C-92	diffuse proximity	M12 connector	PNP-light	952501000
SL5-5-F-82	receiver	M12 connector	PNP-dark	952501020
SL5-5-F-92	receiver	M12 connector	PNP-light	952501050
SL5-5-G-82	emitter	M12 connector	-	952501030

ACCESSORY SELECTION AND ORDER INFORMATION

MODEL	DESCRIPTION	CODE N°
R1	Ø 23 mm prismatic reflector with Ø 31 mm support	S940700023
R2	Ø 48 mm prismatic reflector with Ø 63 mm support	S940700048
R3	18 x 54 mm prismatic reflector with 22 x 82 mm support	S940700972
R4	47 x 47 mm prismatic reflector with 51.5 x 61 mm support	95A151010
R5	Ø 75 mm prismatic reflector with Ø 82 mm support	S940700075
R6	36 x 55 mm prismatic reflector with 40.5 x 60 mm support	95A151020
R7	38 x 40 mm microprism reflector with 51 x 60.7 mm support	95A151050
R8	9.7 x 19 mm microprism reflector with 13.8 x 23 mm support	95A151060
S12	Ø 48 mm prismatic reflector with CH.52 mm hexagon support	S940710048
SP-40	fixed support for tubular M18 sensors	95ACC1370
SWING-18	adjustable support for tubular M18 sensors	895000006
MICRO-18	support with micrometric regulation for tubular M18 sensors	95ACC1380

Please refer also to **Sensor Accessories**.

The company endeavours to continuously improve and renew its products; for this reason the technical data and contents of this catalogue may undergo variations without prior notice. For correct installation and use, the company can guarantee only the data indicated in the instruction manual supplied with the products.