



S70

Advanced fiber optic amplifiers for high speed and low contrast applications

- DIN rail mountable models with dual digital displays
- High speed models: 200 μ s...5 ms
- Super high speed models: 10 μ s...1ms
- Teach-in setting via +/SET/- push-button/switch, remote input or IO-Link
- Standard 2 m cable or M8 4-pole connection

APPLICATIONS

- Processing and Packaging machinery
- Electronics assembling
- Pharmaceutical industry



SENSORS

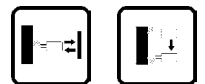

S70	
Response time	Super high speed: 10 μ s (S70...E2) High speed: 200 μ s (S70...E1), 15 μ s (S70...E2) Fast: 50 μ s (S70...E2) Standard: 500 μ s (S70...E1), 250 μ s (S70...E2) Medium range: 500 μ s (S70...E2) Long range: 2 ms (S70...E1), 1 ms (S70...E2) Extra long range: 5 ms (S70...E1)
Repeatability	Super high speed: 5 μ s (S70...E2) High speed: 66 μ s (S70...E1), 5 μ s (S70...E2) Fast: 12 μ s (S70...E2) Standard: 100 μ s (S70...E1), 50 μ s (S70...E2) Medium range: 80 μ s (S70...E2) Long range: 100 μ s (S70...E1), 165 μ s (S70...E2) Extra long range: 100 μ s (S70...E1)
Power supply	Vdc Vac Vac/dc
Output	PNP NPN NPN/PNP relay other IO-Link
Connection	cable connector pig-tail
Approximate dimensions (mm)	10x79x31.5
Housing material	ABS and polycarbonate
Mechanical protection	IP50, NEMA 1

TECHNICAL DATA	
Power supply	10...30 Vdc (reverse polarity protection) 18...30 Vdc (IO-Link mod. S70...PZ)
Ripple	10% max.
Consumption (output current excluded)	40 mA max. (standard display mode), 30 mA max. (ECO display mode)
Light emission	red 660 nm (mod. S70...E1) red 635 nm (mod. S70...E2)
Setting	+ / SET / - push-button, LIGHT / DARK switch, RUN / PRG / ADJ mode switch
Indicators	yellow OUTPUT LED red SIGNAL LEVEL 4-digit display green THRESHOLD 4-digit display
Output	PNP or NPN PNP and push-pull (IO-Link mod. S70...PZ)
Output current	100 mA max.
Saturation voltage	1,5 V max. (mod. S70...N) 2 V max. (mod. S70...P/PZ)
Response time	S70...E1: 200 μ s (High Speed), 500 μ s (Standard), 2 ms (Long Range), 5 ms (Extra Long Range) S70...E2: 10 μ s (Super High Speed), 15 μ s (High Speed), 50 μ s (Fast), 250 μ s (Standard), 500 μ s (Medium Range), 1 ms (Long Range)
Switching frequency	S70...E1: 2,5 kHz (High Speed), 1 kHz (Standard), 250 Hz (Long Range), 100 Hz (Extra Long Range) S70...E2: 50 kHz (Super High Speed), 33 kHz (High Speed), 10 kHz (Fast), 2 kHz (Standard), 1 kHz (Medium Range), 500 Hz (Long Range)
IO-Link interface	baud rate: 38400 bps (COM2) process data width: 16 bits IODD files: provide all programming options of top panel interface, plus additional functionality
Connection	2 m cable, M8 4-pole connector
Dielectric strength	500 Vac, 1 min between electronics and housing
Insulating resistance	>20 M Ω , 500 Vdc between electronics and housing
Electrical protection	class 2
Mechanical protection	IP50, NEMA 1
Ambient light rejection	according to EN 60947-5-2
Vibrations	0,5 mm amplitude, 10 ... 55 Hz frequency, for every axis (EN60068-2-6)
Shock resistance	11 ms (30 G) 6 shock for every axis (EN60068-2-27)
Housing material	ABS and polycarbonate
Operating temperature	-10 ... 55 $^{\circ}$ C
Storage temperature	-25 ... 85 $^{\circ}$ C
Weight	69 g max. cable vers., 21 g max. conn. vers.

DIMENSIONS

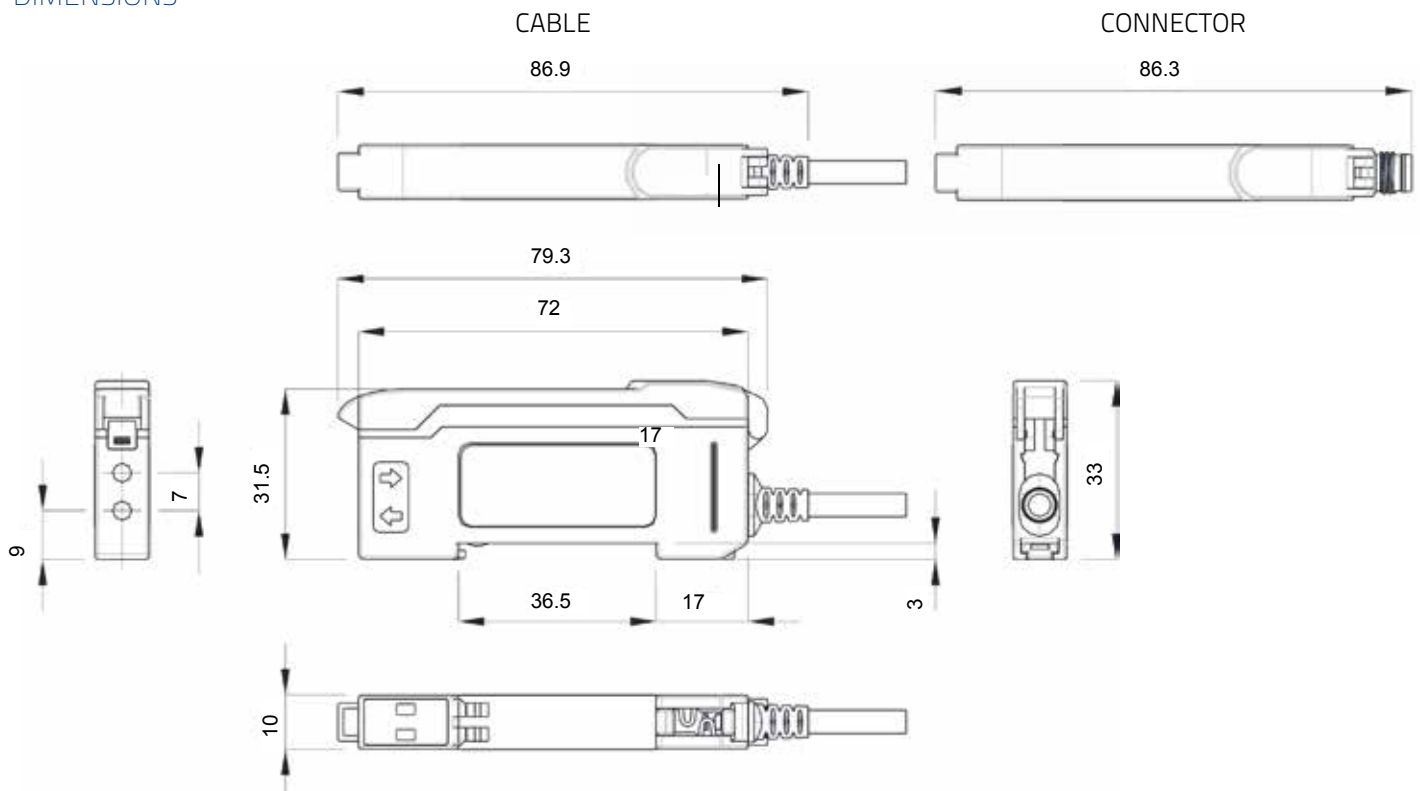

CONNECTIONS

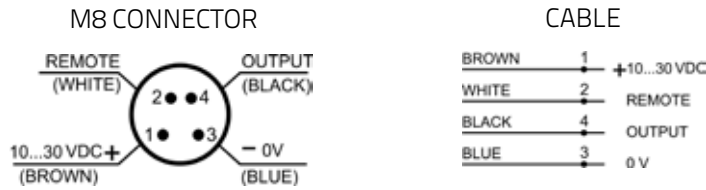

INDICATOR AND SETTINGS

The **RUN/PRG/ADJ Mode Switch** puts the sensor in RUN, PRG (Program), or ADJ (Adjust) mode. RUN mode allows the sensor to operate normally and prevents unintentional programming changes via the **+ /SET/ - button**. PRG mode allows the sensor to be programmed through the display driven programming menu. ADJ mode allows the user to perform TEACH and SET methods and Manual Adjust.

The **LO/DO Switch** is used to select Light Operate or Dark Operate mode.

Top Panel Interface

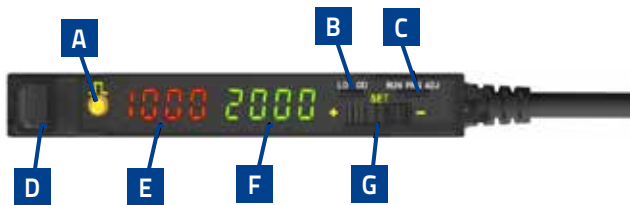

- A Output LED
- B LO/DO Switch
- C RUN/PRG/ADJ
- D Lever Action Fiber Clamp
- E Red Signal Level
- F Green Threshold
- G +/SET/- Rocker Button

As an alternative the sensor can be programmed remotely and the remote input may be used to perform TEACH and SET methods (not available on IO-Link models).

DETECTION DIAGRAMS

	S70-E1			
	HIGH SPEED	STANDARD	LONG RANGE	EXTRA LONG RANGE
Response Time	200 μ s	500 μ s	2 ms	5 ms
Repeatability	66 μ s	100 μ s	100 μ s	100 μ s

Excess gain

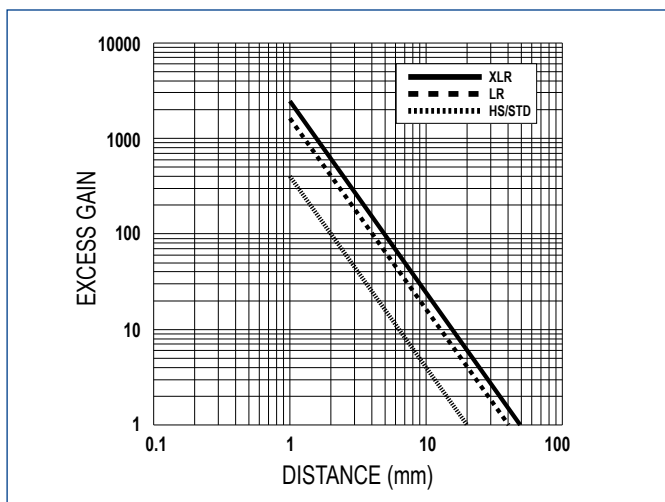

Through beam with 0.2 mm internal fiber optic diameter

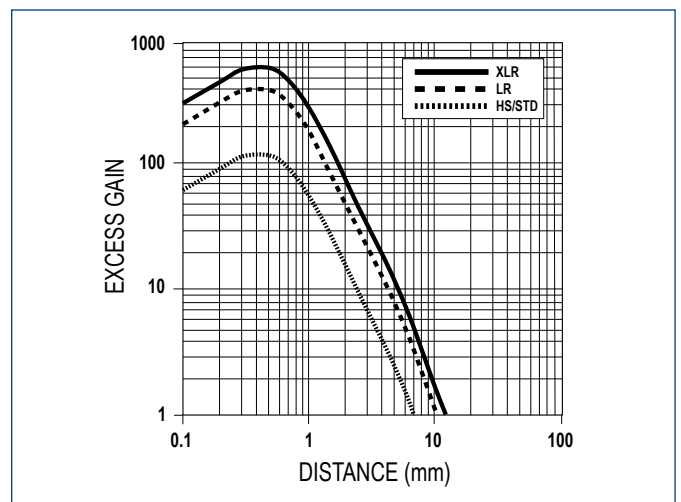

Diffuse proximity with 0.2 mm internal fiber optic diameter

Excess gain

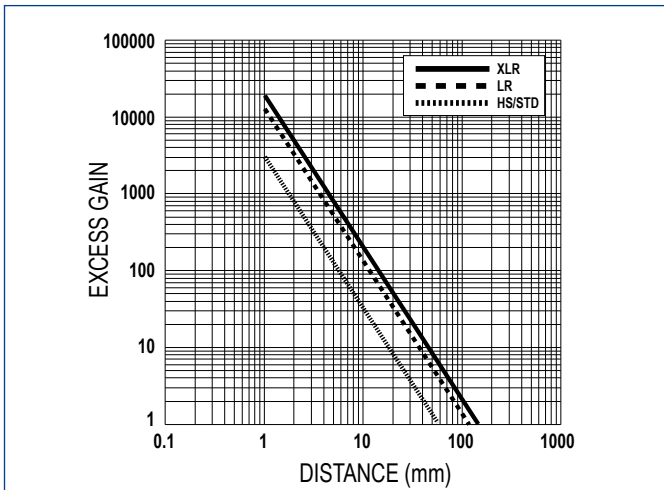

Through beam with 0.5 mm internal fiber optic diameter

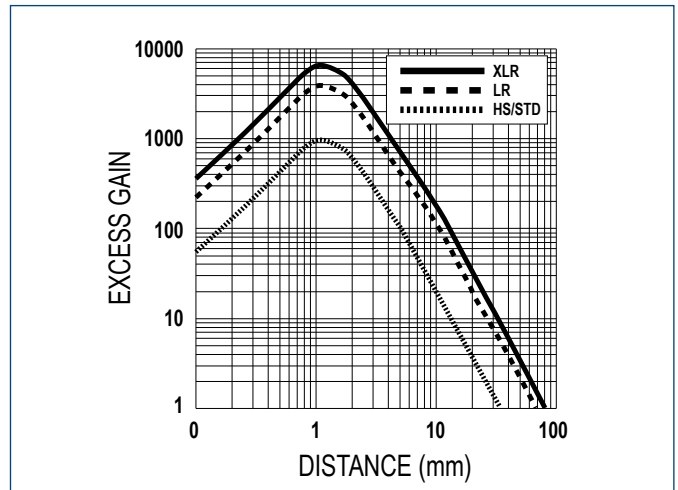

Diffuse proximity with 0.5 mm internal fiber optic diameter

Excess gain

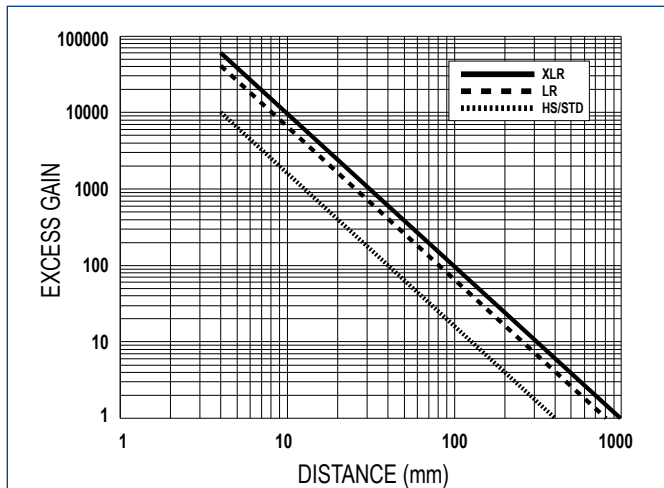

Through beam with 1 mm internal fiber optic diameter

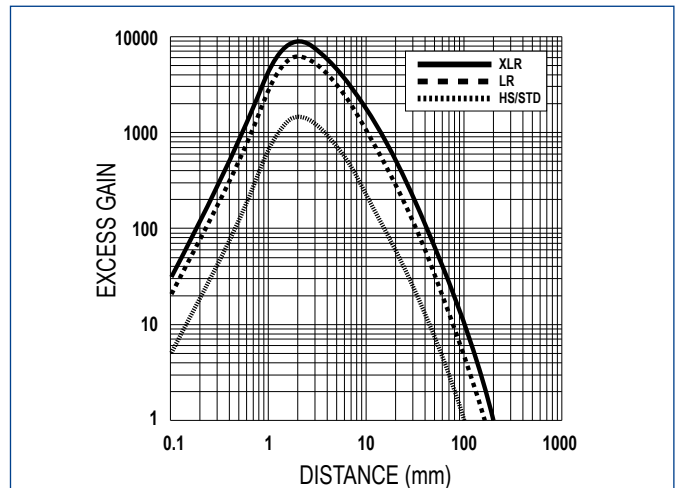

Diffuse proximity with 1 mm internal fiber optic diameter

Excess gain

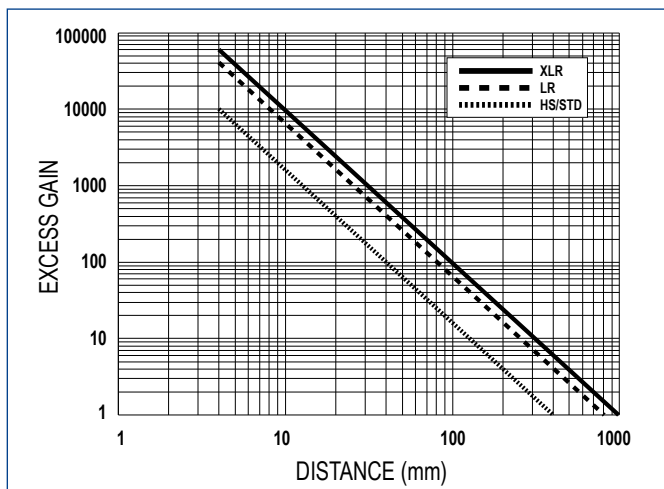

Through beam with 1.5 mm internal fiber optic diameter

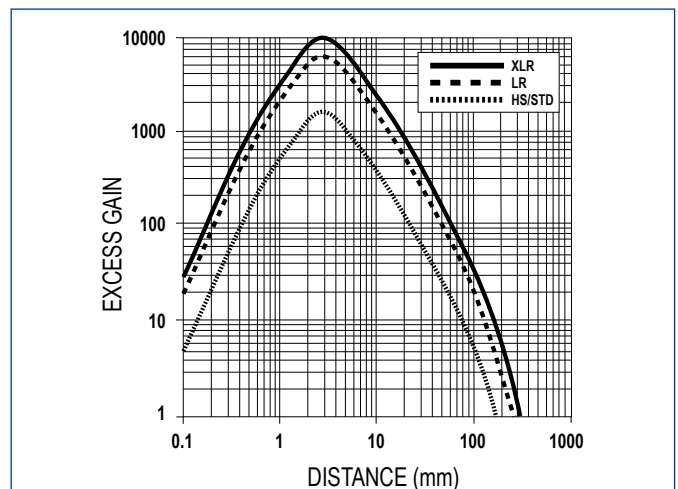

Diffuse proximity with 1.5 mm internal fiber optic diameter

S70-E1				
	HIGH SPEED	STANDARD	LONG RANGE	EXTRA LONG RANGE
Response Time	200 μ s	500 μ s	2 ms	5 ms
Repeatability	66 μ s	100 μ s	100 μ s	100 μ s

Detection area

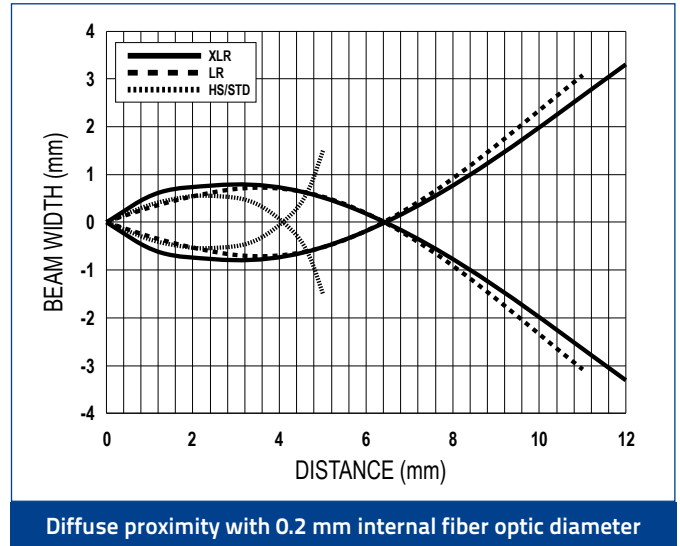
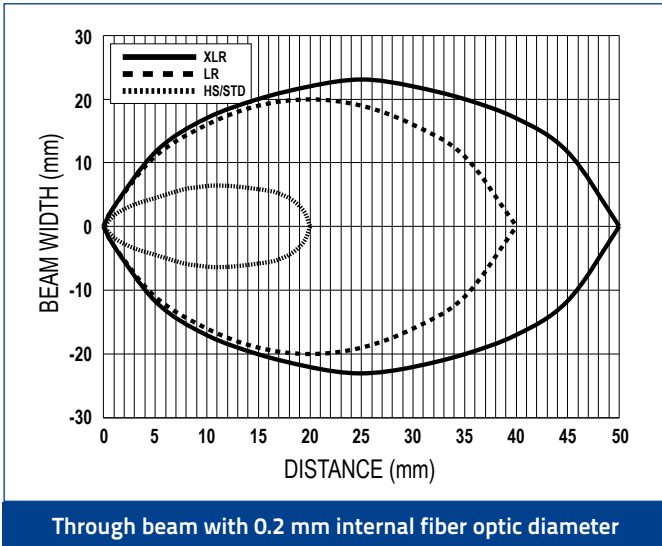

Detection area

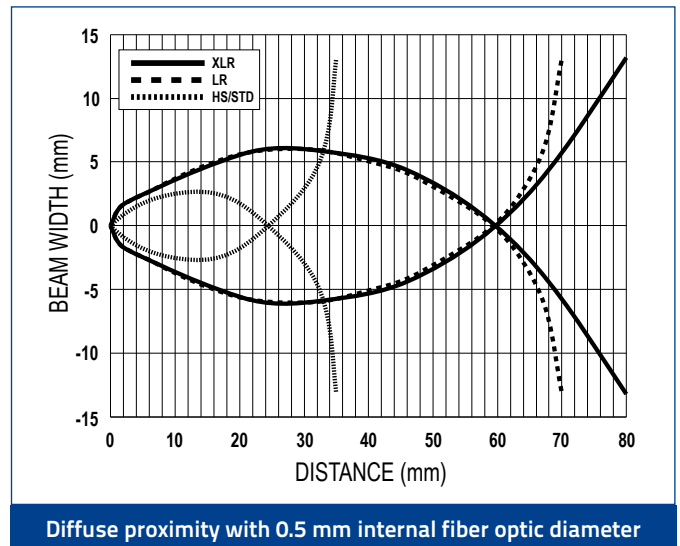
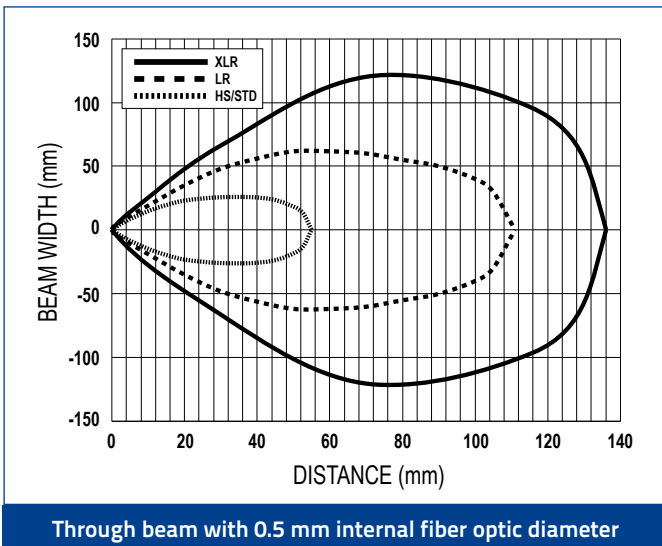

S70-E1				
	HIGH SPEED	STANDARD	LONG RANGE	EXTRA LONG RANGE
Response Time	200 μ s	500 μ s	2 ms	5 ms
Repeatability	66 μ s	100 μ s	100 μ s	100 μ s

Detection area

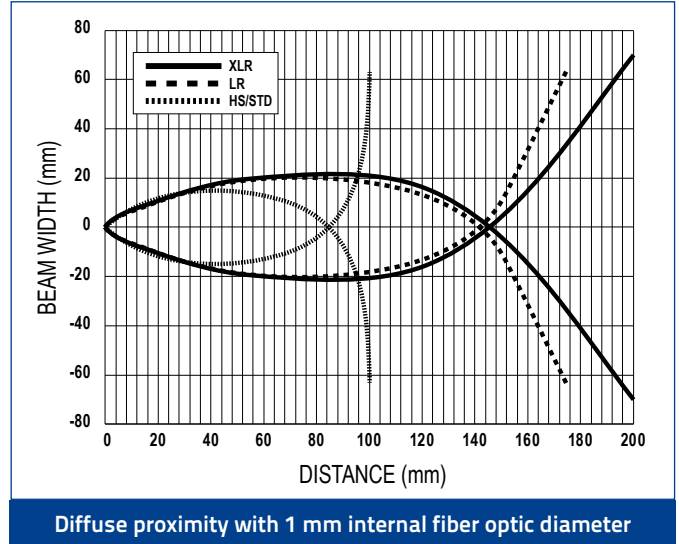
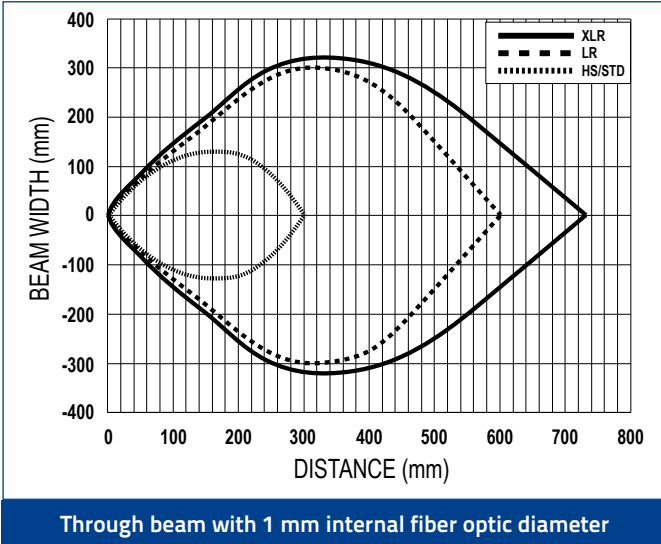

Detection area

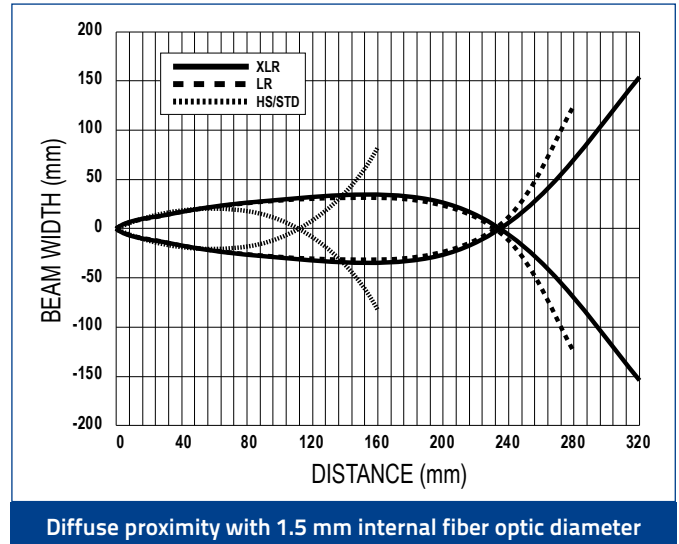
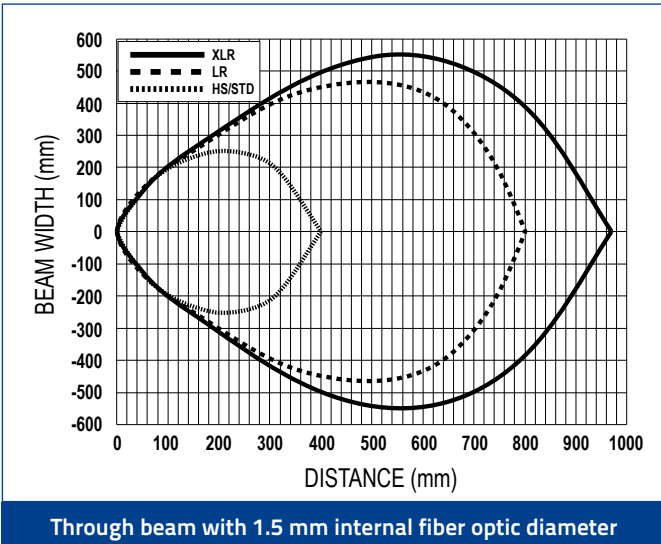

S70-E2						
	SUPER HIGH SPEED	HIGH SPEED	FAST	STANDARD	MEDIUM RANGE	LONG RANGE
Response Time	10 μ s	15 μ s	50 μ s	250 μ s	500 μ s	1 ms
Repeatability	5 μ s	5 μ s	12 μ s	50 μ s	80 μ s	165 μ s

Excess gain

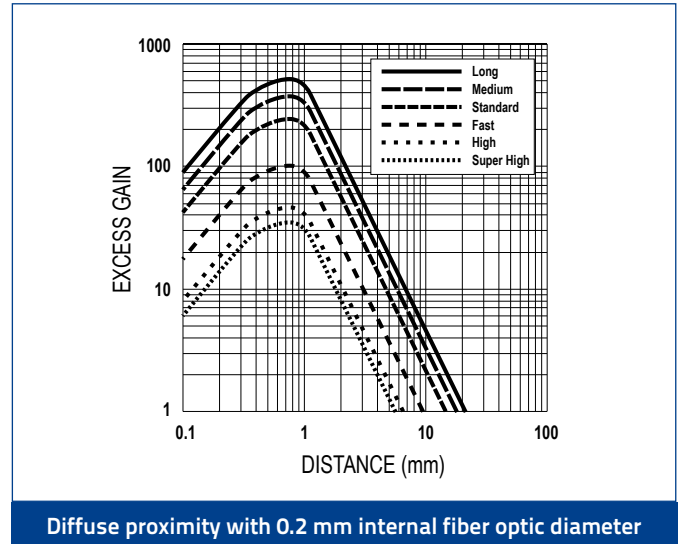
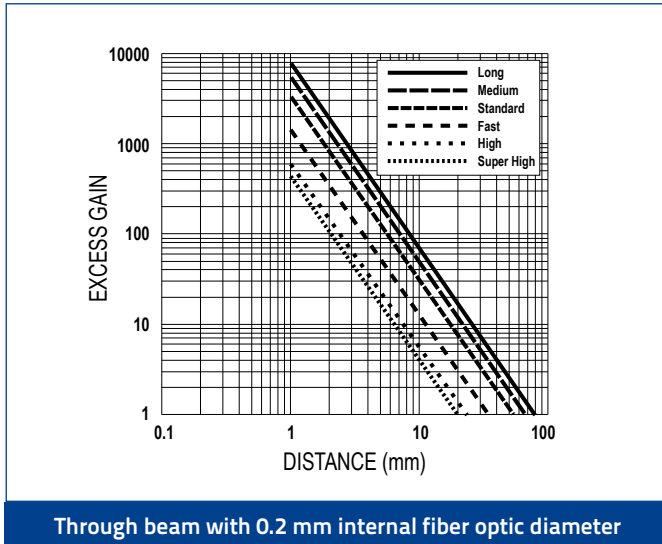

Excess gain

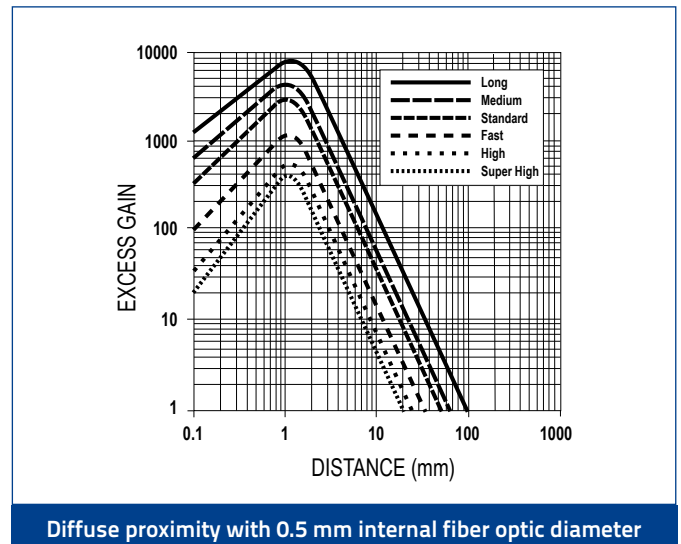
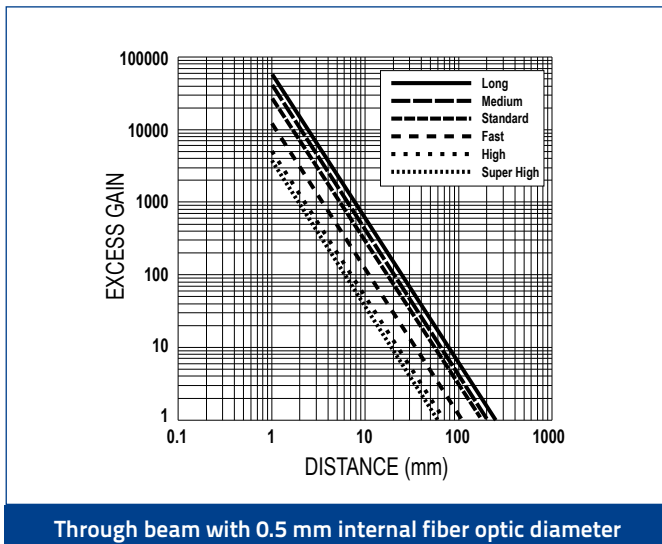

S70-E2						
	SUPER HIGH SPEED	HIGH SPEED	FAST	STANDARD	MEDIUM RANGE	LONG RANGE
Response Time	10 μ s	15 μ s	50 μ s	250 μ s	500 μ s	1 ms
Repeatability	5 μ s	5 μ s	12 μ s	50 μ s	80 μ s	165 μ s

Excess gain

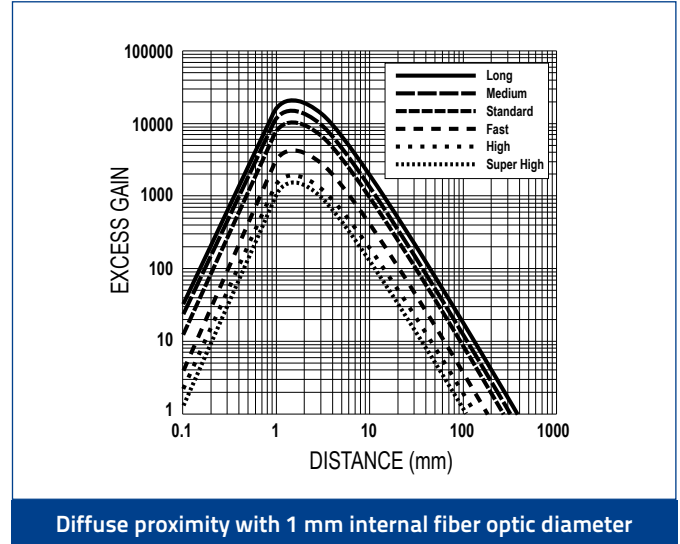
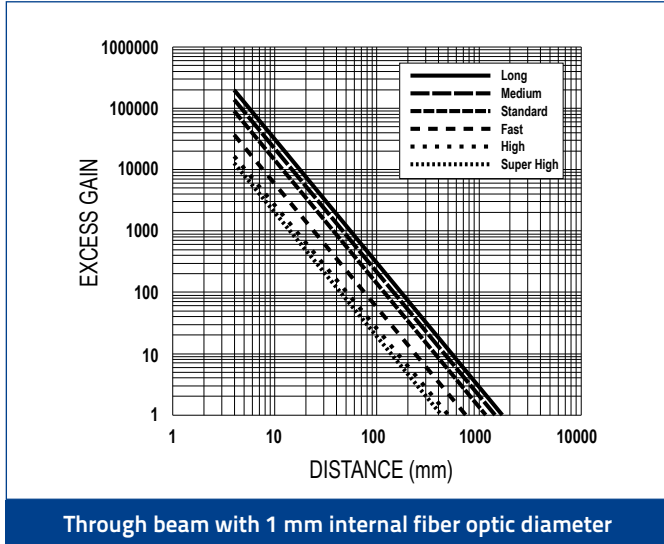

Excess gain

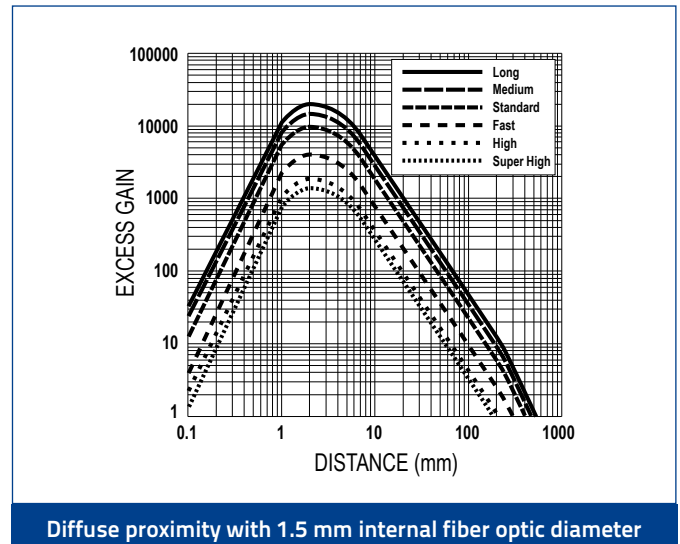
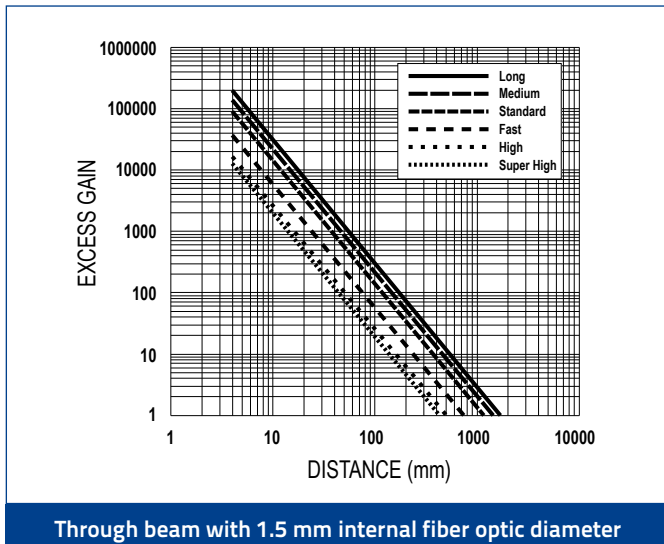

S70-E2						
	SUPER HIGH SPEED	HIGH SPEED	FAST	STANDARD	MEDIUM RANGE	LONG RANGE
Response Time	10 μ s	15 μ s	50 μ s	250 μ s	500 μ s	1 ms
Repeatability	5 μ s	5 μ s	12 μ s	50 μ s	80 μ s	165 μ s

Detection area

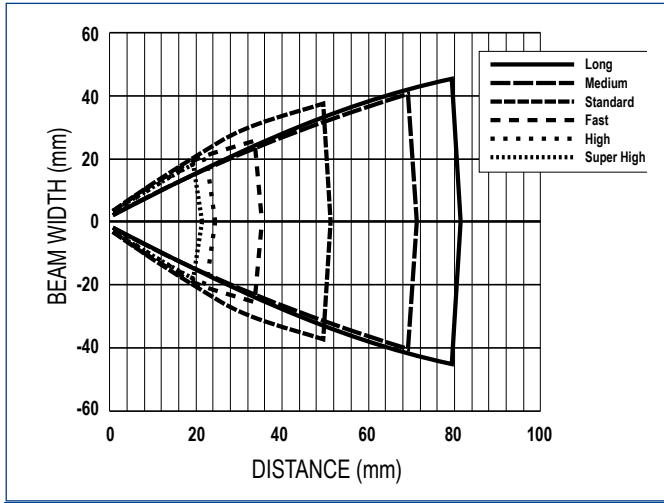

Through beam with 0.2 mm internal fiber optic diameter

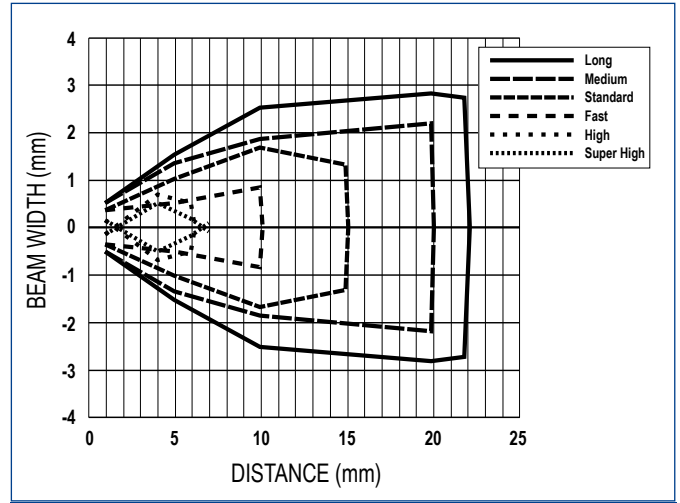

Diffuse proximity with 0.2 mm internal fiber optic diameter

Detection area

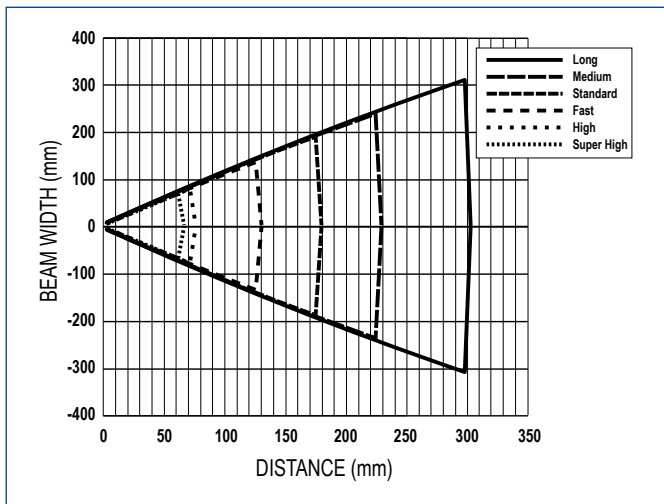

Through beam with 0.5 mm internal fiber optic diameter

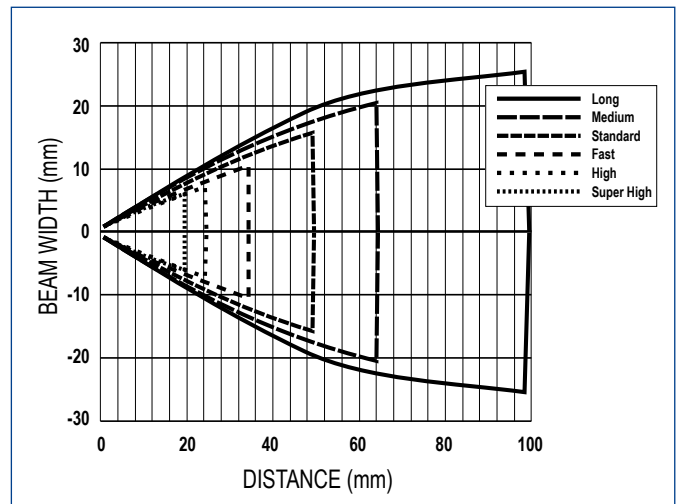

Diffuse proximity with 0.5 mm internal fiber optic diameter

S70-E2						
	SUPER HIGH SPEED	HIGH SPEED	FAST	STANDARD	MEDIUM RANGE	LONG RANGE
Response Time	10 μ s	15 μ s	50 μ s	250 μ s	500 μ s	1 ms
Repeatability	5 μ s	5 μ s	12 μ s	50 μ s	80 μ s	165 μ s

Detection area

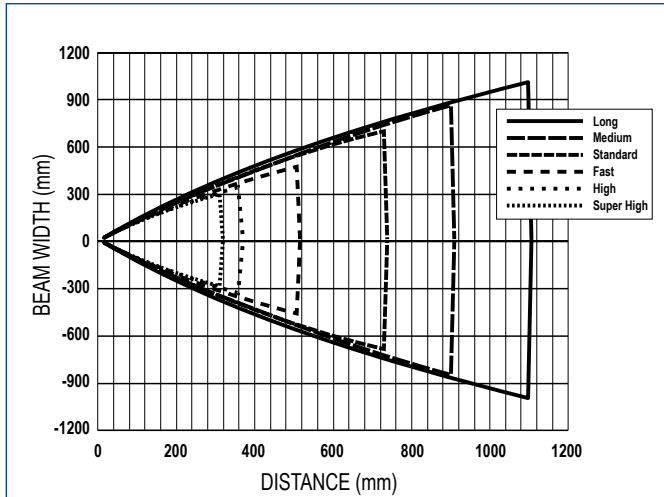

Through beam with 1 mm internal fiber optic diameter

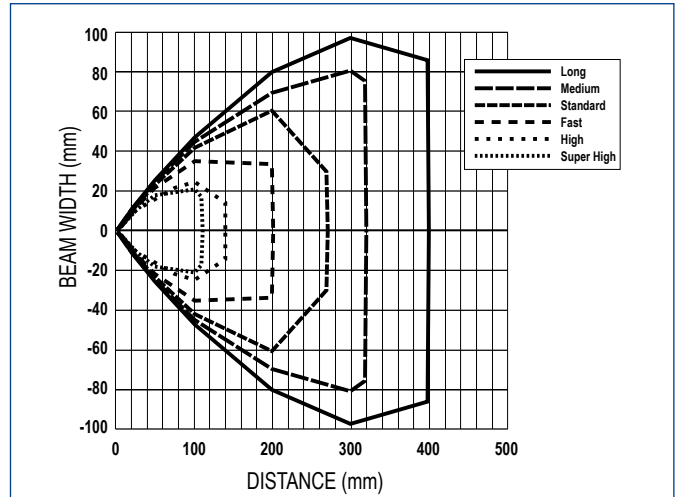

Diffuse proximity with 1 mm internal fiber optic diameter

Detection area

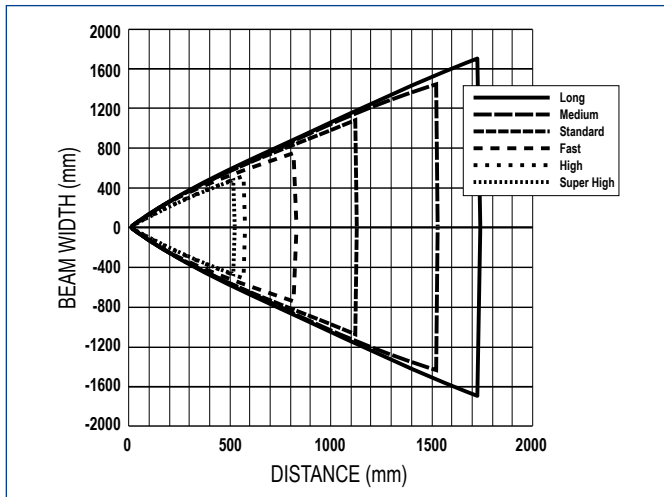

Through beam with 1.5 mm internal fiber optic diameter

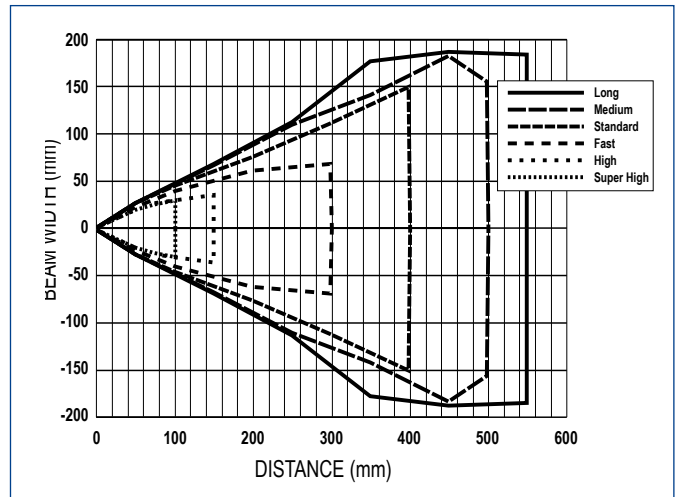

Diffuse proximity with 1.5 mm internal fiber optic diameter

MODEL SELECTION AND ORDER INFORMATION

OPTIC FUNCTION	RESPONSE TIME	CONNECTION	OUTPUT	MODEL	ORDER No.
Optic fiber	200 μ s ... 5 ms	2 m Cable	NPN	S70-2-E1-N	950561000
			PNP	S70-2-E1-P	950561010
		M8 Connector	NPN	S70-5-E1-N	950561060
			PNP	S70-5-E1-P	950561020
	10 μ s ... 1 ms	M8 Connector	PNP, push-pull IO-Link	S70-5-E1-PZ	950561030
			NPN	S70-5-E2-N	950561040
		M8 Connector	PNP	S70-5-E2-P	950561050

ACCESSORIES

CRD-5000

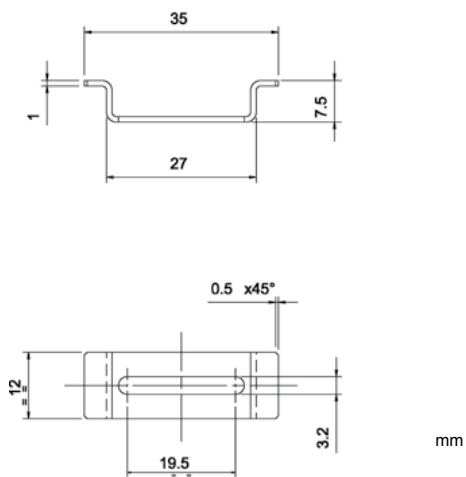

mm

MODEL	DESCRIPTION	ORDER No.
CRD-5000	DIN rail mounting bracket	95ACC2790

CABLES

TYPE	DESCRIPTION	LENGTH	MODEL	ORDER No.
Axial M8 Connector	4-pole, grey, P.V.C.	3 m	CS-B1-02-G-03	95A251420
		5 m	CS-B1-02-G-05	95A251430
		7 m	CS-B1-02-G-07	95A251440
		10 m	CS-B1-02-G-10	95A251480
	4-pole, P.U.R.	2 m	CS-B1-02-R-02	95A251620
		5 m	CS-B1-02-R-05	95A251640
Radial M8 Connector	4-pole, grey, P.V.C.	3 m	CS-B2-02-G-03	95A251450
		5 m	CS-B2-02-G-05	95A251460
		7 m	CS-B2-02-G-07	95A251470
		10 m	CS-B2-02-G-10	95A251530
	4-pole, P.U.R.	2 m	CS-B2-02-R-02	95A251630
		5 m	CS-B2-02-R-05	95A251650

